



New Release - Latest Technology



GUARDIAN™ ***Lightning Protection*** ***System 5***

LIGHTNING PROTECTION INTERNATIONAL PTY LTD



Who is LPI?

Lightning Protection International Pty Ltd (LPI) is a fully owned Australian manufacturer and supplier of direct strike lightning, surge & transient protection equipment and earthing products and solutions to a wide range of industries throughout the world.

LPI personnel and their associates have combined experience over many years in servicing customers throughout the world on many types of projects in some of its most lightning prone areas. Our personnel have vast experience in providing direct strike area protection, surge and transient protection and earthing solutions. Our extensive experience has involved risk management, system design, training, certification and installation and commissioning in key industry groups such as:

- Telecommunications and Broadcasting
- Petrochemical, oil & gas
- Highrise buildings and hotels – all types of structures
- Sporting centre and grounds – Golf courses, race tracks, stadiums
- Aviation - Civil & Military
- Mining – coal, gold, nickel, iron, copper, bauxite etc.
- Industrial facilities of all kinds
- Defence – communications, surveillance and storage of armaments
- Power generation and distribution
- Rail / transport systems
- Monuments / Ecological sites

Guardian CAT terminal has been developed utilising the latest field and research data.

LPI Product Offering

Lightning Protection International Pty Ltd offers a comprehensive range of products and services as part of its complete solution to your lightning problems. These products cover direct strike protection, surge and transient protection and earthing solutions.

- Range of lightning air terminals and accessories
- Surge and transient protection products for powerlines, data, communications and signal lines
- EXOWELD range of exothermic welding products
- Earth rods and accessories including earth enhancing compounds

LPI's Guardian System 5

LPI offers a family of air terminals and accessories. Our product design is based on the most recent advances in the field whilst maintaining proven principles associated with the successes of the past.

LPI's Guardian System 5 provides a purpose-designed package for direct lightning protection.

1. A Family of LPI CAT (Controlled Advanced Triggering) series air terminals.
2. A Fibreglass Reinforced Plastic (FRP) mast which provides an insulated mast for mounting of LPI CAT series air terminals.
3. A purpose designed LPI High Voltage Shielded Cable (HVSC) specifically designed for the conveying of lightning energy to ground. Alternatively, depending on the local codes and applications, other materials such as flat copper tape or stranded cable may be used.
4. LPI Lightning Strike Recorder (LSR) which confirms system efficiency and effectiveness.
5. An earthing system consisting of earth rods, clamps, copper tapes and earth enhancing compounds such as LPI Ground Resistance Improvement Powder (GRIP) or LPI Reslo.

The LPI Guardian System 5 provides a safe and efficient system for the protection of your facility from direct lightning strikes. The LPI CAT terminal captures the lightning discharge at a preferred point and the energy is transferred to ground via the High Voltage Shielded Cable with minimal risk of electrifying the structure. Once the energy enters the dedicated lightning earth, it is safely dissipated without risk to personnel and equipment.



Terminals

LPI Guardian™ CAT series terminals consist of

- A finial with a blunt tip
- An electrically “floating” medium consisting of 4 electrically isolated panels
- A triggering procedure which allows for an intercepting streamer to be released at the correct time, thus providing the greatest possible area of protection
- A high voltage connection at the base of the finial

LPI offers 4 models within the family of CAT terminals

- CAT I - G
- CAT I GI-G
- CAT II - G
- CAT III - G

GI Model – For direct mounting to 2 inch GI Pipe.



What is lightning?

Lightning initiates from an electrical storm which usually generates within a cumulonimbus cloud.

When electrical energy has built up within such a cloud a “leader” of energy leaves it and will try to attach itself to a point on the ground which contains the most particles of energy of reverse polarity.

Some 90% of such “leaders” contain negative charges.

It has long been the endeavour of lightning protection specialists such as LPI to create a preferred point of attachment as offered by the LPI Guardian terminal and in more recent times, to do so effectively so that larger areas of protection can therefore be provided from a single lightning terminal.

WORLD THUNDERSTORM DAYS

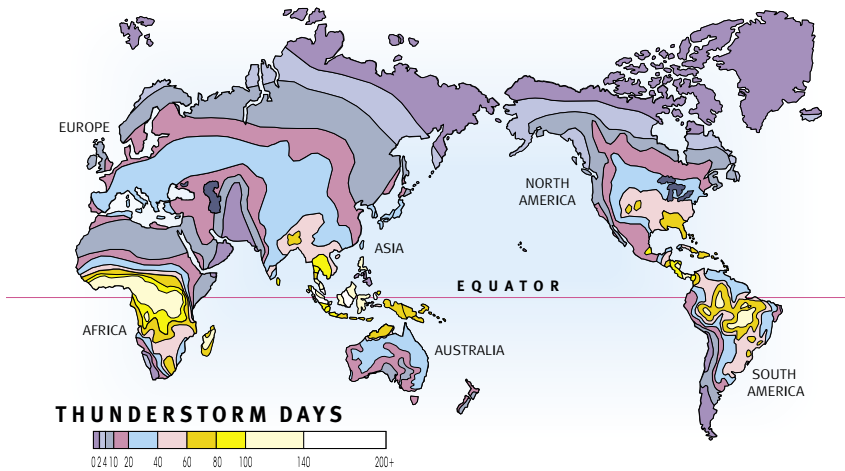

Typical formation of lightning

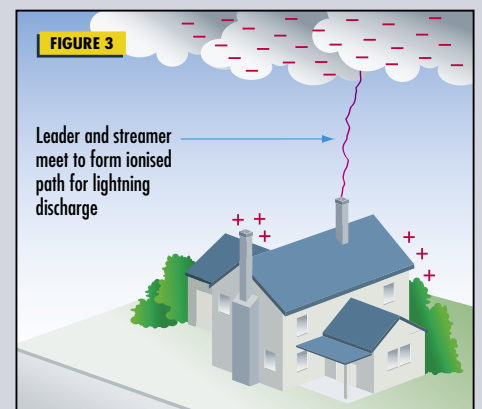
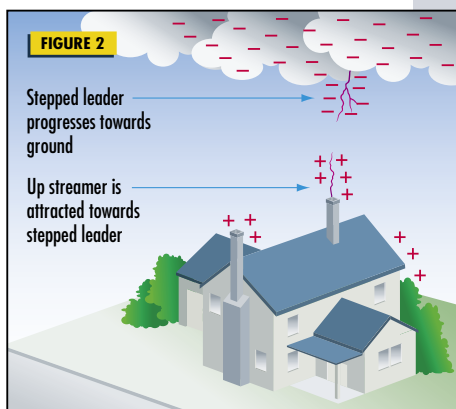
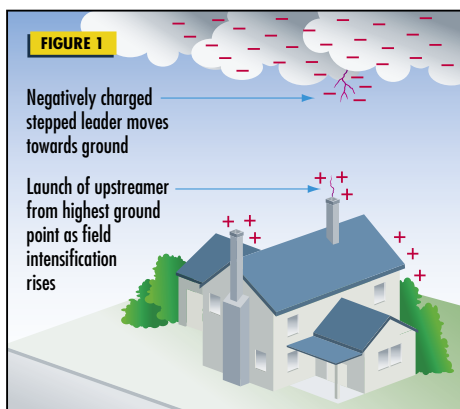

Principles of the LPI Guardian™

The LPI Guardian™ CAT series are Controlled Advanced Triggering devices which intercept lightning discharges for the safe passage to a low impedance down-conductor system. The Guardian™ terminals have been designed to emit a “streamer” of ionised air at precisely the right time so that an approaching “down leader” is intercepted and brought under control.

The concept of controlled triggering is important because if a “streamer” is launched too early the median or ambient field will not be strong enough to sustain propagation and the “streamer” will stall or die. This will leave space charge behind which may inhibit future “streamer” development. An electric field of $\sim 3\text{MV/m}$ is essential at the tip of the air terminal to initiate a corona streamer but an electric field of $\sim 300\text{kV/m}$ is needed in the region between the air terminal and the down-leader to convert the streamer into an up-leader and to sustain propagation.

The dynamic response of the Guardian terminals to the approach of a lightning down leader is the key – detrimental space charge generation prior to leader approach is suppressed and the Guardian™ launches its streamer at the correct time to ensure both electric field criteria are met thus giving the greatest possible area of protection.

How does an LPI Guardian™ Terminal operate?

A Guardian CAT terminal consists of a grounded blunt lightning rod surrounded by electrically floating metal panels. Rounded or blunt tips have now been proven to be more efficient than sharp points because of a reduced space charge effect. This has been clearly proven in tests conducted at South Baldy Peak in central New Mexico, USA. (Source: "The Measurement of Lightning Rod Responses to Nearby Strikes" by C.B. Moore, G.D. Aulich and W. Rison / 2001.)

During the static thunderstorm phase when the electric fields are steady at 5-15 KV/m the panels present as a relatively low field intensification surface aided by the blunt configuration of the finial tip. This restricts the production of "corona" or "point discharge" ions and is critical because excessive production of ions (corona) results in a "space charge cloud" above the air terminal which tends to mask the electrical field and inhibit the formation and progression of an up-leader. (See step 1).

The panels are isolated from each other as well as from the lightning rod to allow the panel facing the down-leader to rise in voltage due to capacitive coupling with the approaching down-leader. The electric field increases as the lightning down-leader approaches closer causing increased voltage difference between the facing panel and the lightning rod. Eventually the voltage rises to the point where a triggering arc is generated between the facing panel and the lightning rod. (See step 2). By design and appropriate terminal placement this arc occurs at the right time to ensure the resulting streamer will form a stable progressive up-leader. (See step 3).

The triggering arc has two key effects, namely:

- (i) It produces a large number of ions to aid the initiation of an up-leader.
- (ii) It causes a large increase in the electric field at a critical distance from the air terminal, aiding propagation through this critical area. This ensures a more efficient mode of protection with an enhanced area of protection.

Downconductors

Following the successful interception of a lightning discharge by the Guardian terminal, the installation of LPI's High Voltage Shielded Cable allows for the safe passage of the lightning energy to the dedicated lightning earth with reduced risk of side flashing.

HVSC is a high integrity low impedance cable which is particularly effective on structures containing high density human occupancy and those which contain sensitive electronic equipment, volatile liquids and other sensitive applications.

LPI also offers a range of conventional downconductors of all types such as copper tape and stranded cable, bare aluminium, galvanised steel cable and tapes or any of the above in PVC insulated form.

Lightning Strike Recorder (LSR)

LPI have developed a Lightning Strike Recorder (LSR) which is designed for easy mounting on a downconductor to effectively count the number of lightning strikes captured by the Guardian system.

The LSR has a current sensitivity range of 1500A through to a maximum of 220KA @ 8/20µs impulse and operates by sensing current by means of inductive pickup loop. The strike recorder has a mechanical 6 digit display secured within a polycarbonate IP 67 rated enclosure. The LSR is self powered and does not require the use of a battery or any external power source.

STEP 1

Grounded blunt lightning rod
Air gap
Four electrically floating panels
Downconductor
Lightning earth

STEP 2

Triggered arc across air gap initiates streamer
Capacitive coupling
Electrically isolated panels rise in voltage as the electric field increases
Downconductor
Lightning earth

STEP 3

Formation of ionised path for the lightning discharge
Four electrically isolated panels
Downconductor
Lightning earth

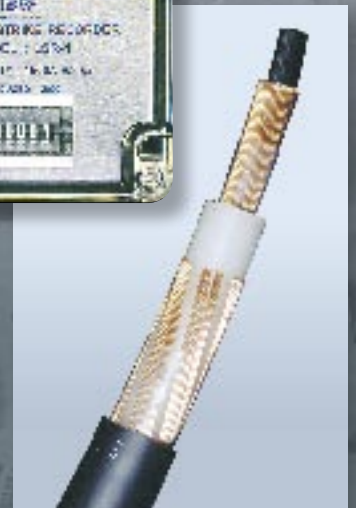

Ground Resistance Improvement Powder (GRIP)

Ground Resistance Improvement Powder is a ground enhancing material which is applied in and around an earthing system to reduce the soil resistivity and lower ground impedance. GRIP is supplied in 10kg and 40kg kits and is particularly useful in difficult sites such as sandy soils and rocky ground. LPI recommends the installation of a radial lightning earth to aid in the efficient dissipation of the lightning energy.

Contact LPI or an authorised representative for design assistance and for further details on LPI's complete range of earth enhancing compounds.



Mounting Mast

LPI offers a selection of masts and mounting accessories for the installation of the Guardian Lightning Protection System 5.

Contact LPI or an authorised representative for specifications of all masts and mounting accessories.

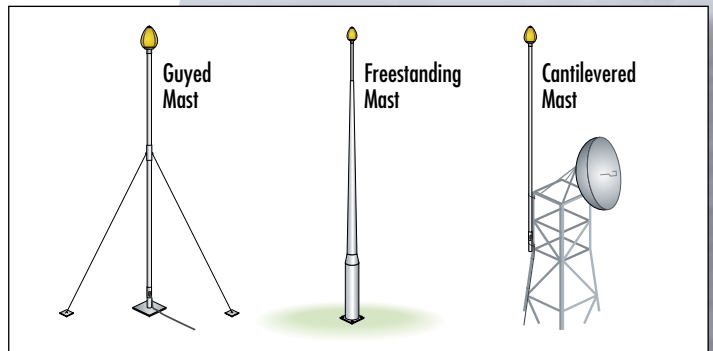

Application

LPI's Guardian CAT series terminals come in three sizes which permits the user to select a terminal which suits his particular application. See the accompanying chart for an indication of the model which best suits your requirements.

For a more accurate design for your project, LPI uses a software based program which accurately takes into consideration important factors relating to your project such as thunderdays per year, height above sea level, level of protection desired / recommended (Standard – High – Very High), physical dimensions of your structures and materials used. Such additional care ensures that competing features (which themselves also have the ability to create streamer development) are taken into consideration.

Unlike other lightning terminal suppliers, LPI consider the development of competing structural features as particularly critical on very tall buildings and on sites that comprise more than one major structure.

Such designs are certified by LPI and therefore offer additional security with regard to the provision of satisfactory lightning protection levels particularly in relation to the lightning activity.

The figures in this table are indicative only, a full design should be completed by LPI upon application. All figures represented as metres (m).

Structure height + installed CAT terminal (typically 5m above Structure)	Protection Level - Very High			Protection Level - High			Protection Level - Standard		
	CAT I	CAT II	CAT III	CAT I	CAT II	CAT III	CAT I	CAT II	CAT III
10	38	44	54	52	60	72	69	80	88
20	46	54	66	63	73	89	74	99	109
30	52	62	75	73	84	118	77	113	120
50		75	92		102	124		128	134
80		75	92		115	124		128	134
100		75	92		115	124		128	134
120		75	92		115	124		128	134
150		75	92		115	124		128	134

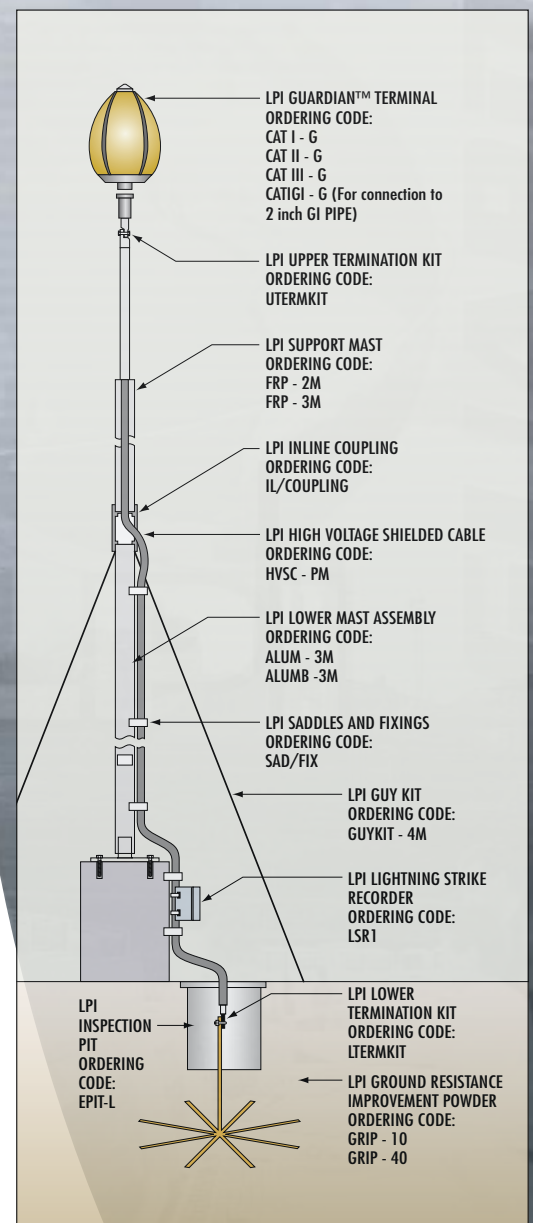

Advantages of Guardian Terminals

1. For most applications, a Guardian System consists of a single CAT lightning terminal which provides an enhanced area of protection, a single purpose designed shielded downconductor for sensitive structures, or a conventional type for standard structures and a single low impedance grounding system.
2. LPI's software based placement program can determine the number and location of terminals required for your project.
3. LPI's system can be installed to comply with most lightning protection standards.
4. LPI's Guardian system is simple to install and requires no special maintenance.
5. LPI's Guardian is a very economical solution for providing your lightning protection whilst providing superior security.
6. The design of LPI's CAT terminals are based on the most recent developments and improvements within the industry.

LPI's 4-Step Approach to Lightning Protection

It is the strategic aim of our company to be able to provide a complete packaged solution. LPI has identified 4 key steps when considering the complete approach to lightning protection, ask for our "LPI 4 Step approach to lightning protection".

Our system design approach includes:

- 1** Definition and provision of area protection
- 2** Creation of a bonded earthing system
- 3** Protection of power lines
- 4** Protection of signal, data and communication lines

Research and Development

The company has an ongoing commitment to Research and Development.

LPI personnel and their associates have been involved in a number of field trials throughout lightning prone regions of the world. This experience has extended throughout such countries as Australia, Indonesia, Sri Lanka the USA and South Korea.



LPI Endorsement

Lightning Protection International Pty Ltd forms "Partnerships" with our customers to provide complete lightning, surge and earthing solutions. Our core competence is the ability to consistently deliver superior performance, quality and value to customers in a broad range of market segments.

LPI's Endorsement confirms our assurance of a long-term partnership with our customers and endorses the product quality and performance. All products offered by LPI come with the quality endorsement and compliance with International standards and bodies wherever possible.

Disclaimer

- LPI maintains a policy of on-going product development, specifications are subject to change without notice.
- Application detail, illustrations and schematic drawings are representative only and should be used as guides.
- It should be noted that 100% (100 percent) protection level for direct strike lightning and surge and transient protection equipment is not possible and cannot be provided due to the lightning discharge process being a natural atmospheric event.

LIGHTNING PROTECTION INTERNATIONAL PTY. LTD.

ABN 11 099 190 897



16 Mertonvale Circuit, Kingston
Tasmania, Australia 7050.

Telephone: + 61 3 6227 1955
Facsimile: + 61 3 6229 1900
Email: info@lpi.com.au

Web: www.lpi.com.au