

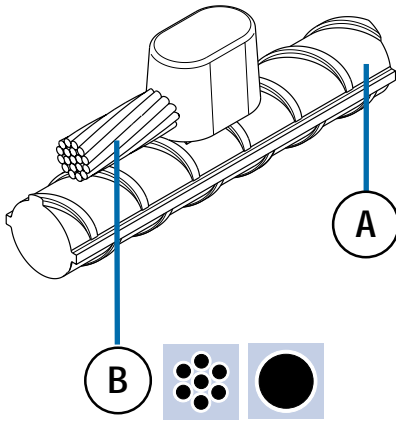



CRE1

Cable to reinforcing bar





A mm Ø	B mm ²				
10 - 40	16*	45P10	CRE1-3-16	HCPK3-B	PACK-A
10 - 40	25	45P10	CRE1-3-25	HCPK3-B	PACK-A
10 - 40	35	45P10	CRE1-3-35	HCPK3-B	PACK-A
10 - 40	8mm Ø	90P10	CRE1-3-8SC	HCPK3-B	PACK-A
10 - 40	50	90P10	CRE1-3-50	HCPK3-B	PACK-A
10 - 40	10mm Ø	90P10	CRE1-3-10SC	HCPK3-B	PACK-A
10 - 40	70	90P10	CRE1-3-70	HCPK3-B	PACK-A
10 - 40	95	90P10	CRE1-3-95	HCPK3-B	PACK-A
10 - 40	120	90P10	CRE1-3-120	HCPK3-B	PACK-A

*  1 x S103

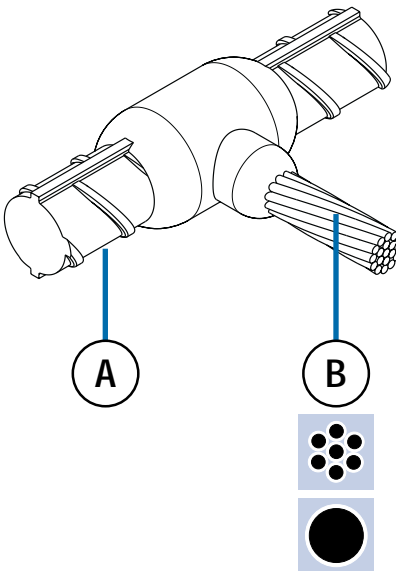
CRE2





A mm Ø	B mm ²			
16	16*	90P10	CRE2-4-16R16	HCPK4
16	25	90P10	CRE2-4-16R25	HCPK4
16	35	90P10	CRE2-4-16R35	HCPK4
16	8mm Ø	115 P10	CRE2-4-16R8SC	HCPK4
16	50	115P10	CRE2-4-16R50	HCPK4
16	10mm Ø	115P10	CRE2-4-16R10SC	HCPK4
16	70	115P10	CRE2-4-16R70	HCPK4
16	95	150P10	CRE2-4-16R95	HCPK4
16	120	150P10	CRE2-4-16R120	HCPK4
16	150	200P10	CRE2-4-16R150	HCPK4
16	185	200P10	CRE2-4-16R185	HCPK4
16	240	250P10	CRE2-4-16R240	HCPK4
16	300	2 x 150P10	CRE2-4-16R300	HCPK4
18	16*	115P10	CRE2-4-18R16	HCPK4
18	25	115P10	CRE2-4-18R25	HCPK4
18	35	115P10	CRE2-4-18R35	HCPK4
18	8mm Ø	150P10	CRE2-4-18R8SC	HCPK4
18	50	150P10	CRE2-4-18R50	HCPK4
18	10mm Ø	150P10	CRE2-4-18R10SC	HCPK4
18	70	150P10	CRE2-4-18R70	HCPK4
18	95	150P10	CRE2-4-18R95	HCPK4
18	120	200P10	CRE2-4-18R120	HCPK4
18	150	200P10	CRE2-4-18R150	HCPK4
18	185	200P10	CRE2-4-18R185	HCPK4
18	240	250P10	CRE2-4-18R240	HCPK4
18	300	2 x 150P10	CRE2-4-18R300	HCPK4
20	16*	115P10	CRE2-4-20R16	HCPK4
20	25	115P10	CRE2-4-20R25	HCPK4
20	35	115P10	CRE2-4-20R35	HCPK4
20	8mm Ø	150P10	CRE2-4-20R8SC	HCPK4
20	50	150P10	CRE2-4-20R50	HCPK4
20	10mm Ø	150P10	CRE2-4-20R10SC	HCPK4
20	70	150P10	CRE2-4-20R70	HCPK4
20	95	200P10	CRE2-4-20R95	HCPK4
20	120	200P10	CRE2-4-20R120	HCPK4
20	150	200P10	CRE2-4-20R150	HCPK4
20	185	250P10	CRE2-4-20R185	HCPK4



*  1 x S103

Cable to reinforcing bar



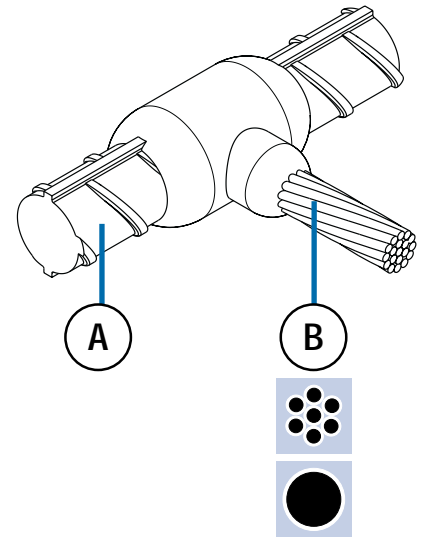

CRE2

A mm Ø	B mm ²			
20	240	2 x 150P10	CRE2-4-20R240	HCPK4
20	300	2 x 200P10	CRE2-5-20R300	HCPK5
25	16	200P10	CRE2-4-25R16	HCPK4
25	25	200P10	CRE2-4-25R25	HCPK4
25	35	200P10	CRE2-4-25R35	HCPK4
25	8mm Ø	200P10	CRE2-4-25R8SC	HCPK4
25	50	200P10	CRE2-4-25R50	HCPK4
25	10mm Ø	250P10	CRE2-4-25R10SC	HCPK4
25	70	250P10	CRE2-4-25R70	HCPK4
25	95	250P10	CRE2-4-25R95	HCPK4
25	120	250P10	CRE2-4-25R120	HCPK4
25	150	2 x 150P10	CRE2-4-25R150	HCPK4
25	185	2 x 150P10	CRE2-5-25R185	HCPK5
25	240	2 x 200P10	CRE2-5-25R240	HCPK5
25	300	2 x 200P10	CRE2-5-25R300	HCPK5
30	16	250P10	CRE2-4-30R16	HCPK4
30	25	250P10	CRE2-4-30R25	HCPK4
30	35	250P10	CRE2-4-30R35	HCPK4
30	8mm Ø	2 x 150P10	CRE2-4-30R8SC	HCPK4
30	50	2 x 150P10	CRE2-4-30R50	HCPK4
30	10mm Ø	2 x 150P10	CRE2-4-30R10SC	HCPK4
30	70	2 x 150P10	CRE2-4-30R70	HCPK4
30	95	2 x 150P10	CRE2-5-30R95	HCPK5
30	120	2 x 200P10	CRE2-5-30R120	HCPK5
30	150	2 x 200P10	CRE2-5-30R150	HCPK5
30	185	2 x 250P10	CRE2-5-30R185	HCPK5
30	240	3 x 200P10	CRE2-5-30R240	HCPK5
30	300	3 x 200P10	CRE2-5-30R300	HCPK5



*  1 x S103

CRE3

A mm Ø	B mm ²				
10 - 40	16	45P10	CRE3-3-16	HCPK3-A	PACK-A
10 - 40	25	45P10	CRE3-3-25	HCPK3-A	PACK-A
10 - 40	35	45P10	CRE3-3-35	HCPK3-A	PACK-A
10 - 40	8mm Ø	90P10	CRE3-3-8SC	HCPK3-A	PACK-A
10 - 40	50	90P10	CRE3-3-50	HCPK3-A	PACK-A
10 - 40	10mm Ø	90P10	CRE3-3-10SC	HCPK3-A	PACK-A
10 - 40	70	90P10	CRE3-3-70	HCPK3-A	PACK-A
10 - 40	95	90P10	CRE3-3-95	HCPK3-A	PACK-A
10 - 40	120	90P10	CRE3-3-120	HCPK3-A	PACK-A



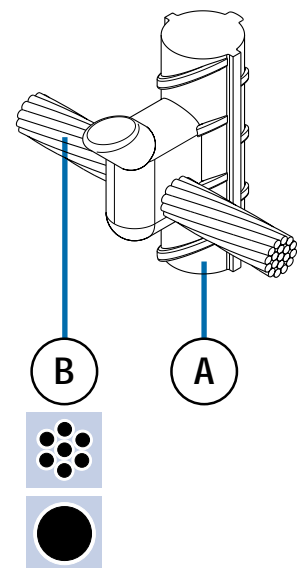

*  2 x S103

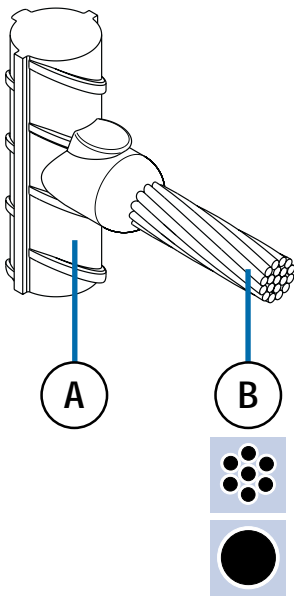

CRE6

Cable to reinforcing bar





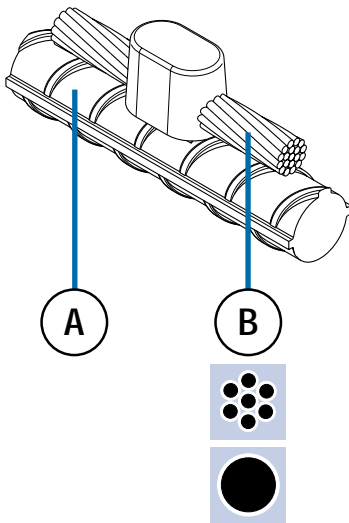

A mm Ø	B mm ²				
10 - 40	16*	45P10	CRE6-3-16	HCPK3-A	PACK-A
10 - 40	25	45P10	CRE6-3-25	HCPK3-A	PACK-A
10 - 40	35	45P10	CRE6-3-35	HCPK3-A	PACK-A
10 - 40	8mm Ø	65P10	CRE6-3-8SC	HCPK3-A	PACK-A
10 - 40	50	65P10	CRE6-3-50	HCPK3-A	PACK-A
10 - 40	10mm Ø	90P10	CRE6-3-10SC	HCPK3-A	PACK-A
10 - 40	70	90P10	CRE6-3-70	HCPK3-A	PACK-A
10 - 40	95	90P10	CRE6-4-95	HCPK3-A	PACK-A
10 - 40	120	90P10	CRE6-4-120	HCPK3-A	PACK-A

*  1 x S103

CRE17



A mm Ø	B mm ²				
10 - 40	16*	45P10	CRE17-3-16	HCPK3-B	PACK-A
10 - 40	25	45P10	CRE17-3-25	HCPK3-B	PACK-A
10 - 40	35	45P10	CRE17-3-35	HCPK3-B	PACK-A
10 - 40	8mm Ø	90P10	CRE17-3-8SC	HCPK3-B	PACK-A
10 - 40	50	90P10	CRE17-3-50	HCPK3-B	PACK-A
10 - 40	10mm Ø	90P10	CRE17-3-10SC	HCPK3-B	PACK-A
10 - 40	70	90P10	CRE17-3-70	HCPK3-B	PACK-A
10 - 40	95	90P10	CRE17-3-95	HCPK3-B	PACK-A
10 - 40	120	90P10	CRE17-3-120	HCPK3-B	PACK-A

*  2 x S103