

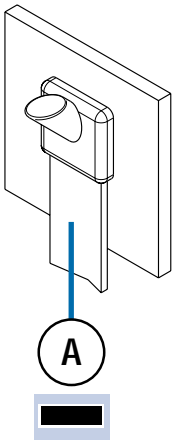





BS1





Bar to steel surface



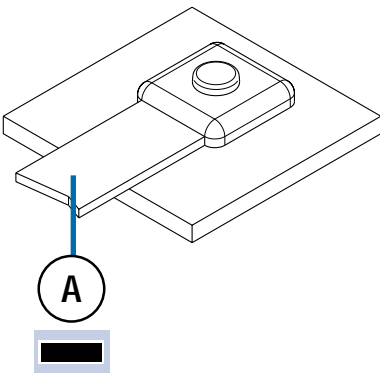





A mm x mm				MINI 	
20 x 3	65P10	BS1-4-203	HCPK4	BS1-3-203	HCPK3
25 x 3	90P10	BS1-4-253	HCPK4	BS1-3-253	HCPK3
25 x 4	90P10	BS1-4-254	HCPK4	BS1-3-254	HCPK3
25 x 6	150P10	BS1-4-256	HCPK4	-	-
30 x 2	90P10	BS1-4-302	HCPK4	BS1-3-302	HCPK3
30 x 3	90P10	BS1-4-303	HCPK4	BS1-3-303	HCPK3
30 x 4	115P10	BS1-4-304	HCPK4	BS1-3-304	HCPK3
30 x 5	150P10	BS1-4-305	HCPK4	-	-
31 x 3	90P10	BS1-4-313	HCPK4	BS1-3-313	HCPK3
31 x 6	200P10	BS1-4-316	HCPK4	-	-
38 x 3	150P10	BS1-4-383	HCPK4	-	-
38 x 5	200P10	BS1-4-385	HCPK4	-	-
38 x 6	250P10	BS1-4-386	HCPK4	-	-
40 x 3	150P10	BS1-4-403	HCPK4	-	-
40 x 4	200P10	BS1-4-404	HCPK4	-	-
40 x 5	200P10	BS1-4-405	HCPK4	-	-
40 x 6	250P10	BS1-4-406	HCPK4	-	-
50 x 3	200P10	BS1-4-503	HCPK4	-	-
50 x 4	250P10	BS1-4-504	HCPK4	-	-
50 x 5	250P10	BS1-4-505	HCPK4	-	-
50 x 6	2 x 150P10	BS1-5-506	HCPK5	-	-

BS2



A mm x mm				MINI 	
20 x 3	90P10	BS2-4-203	HCPK4	BS2-3-203	HCPK3
25 x 3	90P10	BS2-4-253	HCPK4	BS2-3-253	HCPK3
25 x 4	90P10	BS2-4-254	HCPK4	BS2-3-254	HCPK3
25 x 6	150P10	BS2-4-256	HCPK4	-	-
30 x 2	115P10	BS2-4-302	HCPK4	BS2-3-302	HCPK3
30 x 3	115P10	BS2-4-303	HCPK4	BS2-3-303	HCPK3
30 x 4	150P10	BS2-4-304	HCPK4	-	-
30 x 5	200P10	BS2-4-305	HCPK4	-	-
31 x 3	115P10	BS2-4-313	HCPK4	BS2-3-313	HCPK3
31 x 6	200P10	BS2-4-316	HCPK4	-	-
38 x 3	150P10	BS2-4-383	HCPK4	-	-
38 x 5	200P10	BS2-4-385	HCPK4	-	-
38 x 6	200P10	BS2-4-386	HCPK4	-	-
40 x 3	115P10	BS2-4-403	HCPK4	-	-
40 x 4	200P10	BS2-4-404	HCPK4	-	-
40 x 5	200P10	BS2-4-405	HCPK4	-	-
40 x 6	250P10	BS2-4-406	HCPK4	-	-
50 x 3	200P10	BS2-4-503	HCPK4	-	-
50 x 4	2 x 150P10	BS2-5-504	HCPK5	-	-
50 x 5	2 x 150P10	BS2-5-505	HCPK5	-	-
50 x 6	2 x 150P10	BS2-5-506	HCPK5	-	-

Bar to steel surface

 mm x mm				MINI 	
20 x 3	65P10	BS1-4-203	HCPK4	BS1-3-203	HCPK3
20 x 3	90P10	BS3-4-203	HCPK4	BS3-3-203	HCPK3
25 x 3	115P10	BS3-4-253	HCPK4	BS3-3-253	HCPK3
25 x 4	115P10	BS3-4-254	HCPK4	BS3-3-254	HCPK3
25 x 6	150P10	BS3-4-256	HCPK4	-	-
30 x 2	115P10	BS3-4-302	HCPK4	BS3-3-302	HCPK3
30 x 3	115P10	BS3-4-303	HCPK4	BS3-3-303	HCPK3
30 x 4	150P10	BS3-4-304	HCPK4	-	-
30 x 5	200P10	BS3-4-305	HCPK4	-	-
31 x 3	115P10	BS3-4-313	HCPK4	BS3-3-313	HCPK3
31 x 6	200P10	BS3-4-316	HCPK4	-	-
38 x 3	150P10	BS3-4-383	HCPK4	-	-
38 x 5	200P10	BS3-4-385	HCPK4	-	-
38 x 6	250P10	BS3-4-386	HCPK4	-	-
40 x 3	150P10	BS3-4-403	HCPK4	-	-
40 x 4	200P10	BS3-4-404	HCPK4	-	-
40 x 5	250P10	BS3-4-405	HCPK4	-	-
40 x 6	250P10	BS3-4-406	HCPK4	-	-
50 x 3	250P10	BS3-4-503	HCPK4	-	-
50 x 4	250P10	BS3-4-504	HCPK4	-	-
50 x 5	250P10	BS3-4-505	HCPK4	-	-
50 x 6	250P10	BS3-4-506	HCPK4	-	-

