

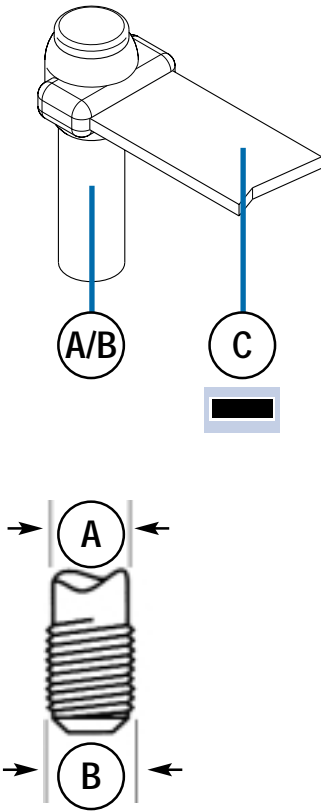





BR1

Bar to earth rod







| A mm Ø | B inches Ø | C mm x mm |  |  |  | MINI  |  |
|-----------|---------------|--------------|---|---|---|---|---|
| 12.7 | 1/2" | 20 x 3 | 90P10 | BR1-4-127203 | HCPK4 | BR1-3-128203 | HCPK3 |
| 12.7 | 1/2" | 25 x 3 | 90P10 | BR1-4-127253 | HCPK4 | BR1-3-128253 | HCPK3 |
| 12.7 | 1/2" | 25 x 4 | 90P10 | BR1-4-127254 | HCPK4 | BR1-3-128254 | HCPK3 |
| 12.7 | 1/2" | 30 x 2 | 90P10 | BR1-4-127302 | HCPK4 | BR1-3-128302 | HCPK3 |
| 12.7 | 1/2" | 30 x 3 | 90P10 | BR1-4-127303 | HCPK4 | BR1-3-128303 | HCPK3 |
| 12.7 | 1/2" | 31 x 3 | 90P10 | BR1-4-127313 | HCPK4 | BR1-3-128313 | HCPK3 |
| 12.7 | 1/2" | 38 x 3 | 90P10 | BR1-4-127383 | HCPK4 | - | - |
| 12.7 | 1/2" | 40 x 3 | 90P10 | BR1-4-127403 | HCPK4 | - | - |
| 12.7 | 1/2" | 50 x 3 | 115P10 | BR1-4-127503 | HCPK4 | - | - |
| 12.7 | 1/2" | 50 x 6 | 115P10 | BR1-4-127506 | HCPK4 | - | - |
| 14.2 | 5/8" | 20 x 3 | 90P10 | BR1-4-142203 | HCPK4 | BR1-3-142203 | HCPK3 |
| 14.2 | 5/8" | 25 x 3 | 90P10 | BR1-4-142253 | HCPK4 | BR1-3-142253 | HCPK3 |
| 14.2 | 5/8" | 25 x 4 | 115P10 | BR1-4-142254 | HCPK4 | BR1-3-142254 | HCPK3 |
| 14.2 | 5/8" | 25 x 6 | 115P10 | BR1-4-142256 | HCPK4 | BR1-3-142256 | HCPK3 |
| 14.2 | 5/8" | 30 x 2 | 115P10 | BR1-4-142302 | HCPK4 | BR1-3-142302 | HCPK3 |
| 14.2 | 5/8" | 30 x 3 | 115P10 | BR1-4-142303 | HCPK4 | BR1-3-142303 | HCPK3 |
| 14.2 | 5/8" | 30 x 4 | 150P10 | BR1-4-142304 | HCPK4 | - | - |
| 14.2 | 5/8" | 30 x 5 | 150P10 | BR1-4-142305 | HCPK4 | - | - |
| 14.2 | 5/8" | 31 x 3 | 115P10 | BR1-4-142313 | HCPK4 | BR1-3-142313 | HCPK3 |
| 14.2 | 5/8" | 31 x 6 | 150P10 | BR1-4-142316 | HCPK4 | - | - |
| 14.2 | 5/8" | 38 x 3 | 115P10 | BR1-4-142383 | HCPK4 | - | - |
| 14.2 | 5/8" | 38 x 5 | 150P10 | BR1-4-142385 | HCPK4 | - | - |
| 14.2 | 5/8" | 38 x 6 | 200P10 | BR1-4-142386 | HCPK4 | - | - |
| 14.2 | 5/8" | 40 x 3 | 115P10 | BR1-4-142403 | HCPK4 | - | - |
| 14.2 | 5/8" | 40 x 4 | 150P10 | BR1-4-142404 | HCPK4 | - | - |
| 14.2 | 5/8" | 40 x 5 | 150P10 | BR1-4-142405 | HCPK4 | - | - |
| 14.2 | 5/8" | 40 x 6 | 200P10 | BR1-4-142406 | HCPK4 | - | - |
| 14.2 | 5/8" | 50 x 3 | 150P10 | BR1-4-142503 | HCPK4 | - | - |
| 14.2 | 5/8" | 50 x 4 | 200P10 | BR1-4-142504 | HCPK4 | - | - |
| 14.2 | 5/8" | 50 x 5 | 200P10 | BR1-4-142505 | HCPK4 | - | - |
| 14.2 | 5/8" | 50 x 6 | 200P10 | BR1-4-142506 | HCPK4 | - | - |
| 17.2 | 3/4" | 20 x 3 | 115P10 | BR1-4-172203 | HCPK4 | BR1-3-172203 | HCPK3 |
| 17.2 | 3/4" | 25 x 3 | 150P10 | BR1-4-172253 | HCPK4 | - | - |
| 17.2 | 3/4" | 25 x 4 | 150P10 | BR1-4-172254 | HCPK4 | - | - |
| 17.2 | 3/4" | 25 x 6 | 200P10 | BR1-4-172256 | HCPK4 | - | - |
| 17.2 | 3/4" | 30 x 2 | 150P10 | BR1-4-172302 | HCPK4 | - | - |
| 17.2 | 3/4" | 30 x 3 | 150P10 | BR1-4-172303 | HCPK4 | - | - |
| 17.2 | 3/4" | 30 x 4 | 250P10 | BR1-4-172304 | HCPK4 | - | - |
| 17.2 | 3/4" | 30 x 5 | 200P10 | BR1-4-172305 | HCPK4 | - | - |
| 17.2 | 3/4" | 31 x 3 | 150P10 | BR1-4-172313 | HCPK4 | - | - |
| 17.2 | 3/4" | 31 x 6 | 250P10 | BR1-4-172316 | HCPK4 | - | - |
| 17.2 | 3/4" | 38 x 3 | 200P10 | BR1-4-172383 | HCPK4 | - | - |
| 17.2 | 3/4" | 38 x 5 | 200P10 | BR1-4-172385 | HCPK4 | - | - |
| 17.2 | 3/4" | 38 x 6 | 2 x 150P10 | BR1-5-172386 | HCPK5 | - | - |
| 17.2 | 3/4" | 40 x 3 | 200P10 | BR1-4-172403 | HCPK4 | - | - |
| 17.2 | 3/4" | 40 x 4 | 200P10 | BR1-4-172404 | HCPK4 | - | - |
| 17.2 | 3/4" | 40 x 5 | 200P10 | BR1-4-172405 | HCPK4 | - | - |
| 17.2 | 3/4" | 40 x 6 | 2 x 150P10 | BR1-5-172406 | HCPK5 | - | - |
| 17.2 | 3/4" | 50 x 3 | 2 x 150P10 | BR1-5-172503 | HCPK5 | - | - |
| 17.2 | 3/4" | 50 x 4 | 2 x 150P10 | BR1-5-172504 | HCPK5 | - | - |
| 17.2 | 3/4" | 50 x 5 | 2 x 150P10 | BR1-5-172505 | HCPK5 | - | - |
| 17.2 | 3/4" | 50 x 6 | 2 x 200P10 | BR1-5-172506 | HCPK5 | - | - |

Suitable for connections to copperbond rods - for connections to solid copper and stainless steel rods please contact our sales office.

Threaded portion of copperbond rods must be removed prior to welding.

Bar to earth rod

| A mm Ø | B inches Ø | C mm x mm |  |  |  | MINI  |  |
|------------------|----------------------|---------------------|---|---|---|--|---|
| 12.7 | 1/2" | 20 x 3 | 90P10 | BR2-4-127203 | HCPK4 | BR2-3-128203 | HCPK3 |
| 12.7 | 1/2" | 25 x 3 | 90P10 | BR2-4-127253 | HCPK4 | BR2-3-128253 | HCPK3 |
| 12.7 | 1/2" | 25 x 4 | 90P10 | BR2-4-127254 | HCPK4 | BR2-3-128254 | HCPK3 |
| 12.7 | 1/2" | 30 x 2 | 90P10 | BR2-4-127302 | HCPK4 | BR2-3-128302 | HCPK3 |
| 12.7 | 1/2" | 30 x 3 | 90P10 | BR2-4-127303 | HCPK4 | BR2-3-128303 | HCPK3 |
| 12.7 | 1/2" | 31 x 3 | 90P10 | BR2-4-127313 | HCPK4 | BR2-3-128313 | HCPK3 |
| 12.7 | 1/2" | 38 x 3 | 90P10 | BR2-4-127383 | HCPK4 | BR2-3-128383 | HCPK3 |
| 12.7 | 1/2" | 40 x 3 | 90P10 | BR2-4-127403 | HCPK4 | BR2-3-128403 | HCPK3 |
| 12.7 | 1/2" | 50 x 3 | 115P10 | BR2-4-127503 | HCPK4 | - | - |
| 14.2 | 5/8" | 20 x 3 | 90P10 | BR2-4-142203 | HCPK4 | BR2-3-142203 | HCPK3 |
| 14.2 | 5/8" | 25 x 3 | 90P10 | BR2-4-142253 | HCPK4 | BR2-3-142253 | HCPK3 |
| 14.2 | 5/8" | 25 x 4 | 115P10 | BR2-4-142254 | HCPK4 | BR2-3-142254 | HCPK3 |
| 14.2 | 5/8" | 25 x 6 | 150P10 | BR2-4-142256 | HCPK4 | - | - |
| 14.2 | 5/8" | 25 x 6 | 150P10 | BR2-4-142256 | HCPK4 | - | - |
| 14.2 | 5/8" | 30 x 2 | 90P10 | BR2-4-142302 | HCPK4 | BR2-3-142302 | HCPK3 |
| 14.2 | 5/8" | 30 x 3 | 115P10 | BR2-4-142303 | HCPK4 | BR2-3-142303 | HCPK3 |
| 14.2 | 5/8" | 30 x 4 | 150P10 | BR2-4-142304 | HCPK4 | - | - |
| 14.2 | 5/8" | 30 x 5 | 150P10 | BR2-4-142305 | HCPK4 | - | - |
| 14.2 | 5/8" | 31 x 3 | 115P10 | BR2-4-142313 | HCPK4 | BR2-3-142313 | HCPK3 |
| 14.2 | 5/8" | 31 x 6 | 150P10 | BR2-4-142316 | HCPK4 | - | - |
| 14.2 | 5/8" | 38 x 3 | 150P10 | BR2-4-142383 | HCPK4 | - | - |
| 14.2 | 5/8" | 38 x 5 | 150P10 | BR2-4-142385 | HCPK4 | - | - |
| 14.2 | 5/8" | 38 x 6 | 200P10 | BR2-4-142386 | HCPK4 | - | - |
| 14.2 | 5/8" | 40 x 3 | 150P10 | BR2-4-142403 | HCPK4 | - | - |
| 14.2 | 5/8" | 40 x 4 | 150P10 | BR2-4-142404 | HCPK4 | - | - |
| 14.2 | 5/8" | 40 x 5 | 150P10 | BR2-4-142405 | HCPK4 | - | - |
| 14.2 | 5/8" | 40 x 6 | 200P10 | BR2-4-142406 | HCPK4 | - | - |
| 14.2 | 5/8" | 50 x 3 | 200P10 | BR2-4-142503 | HCPK4 | - | - |
| 14.2 | 5/8" | 50 x 4 | 200P10 | BR2-4-142504 | HCPK4 | - | - |
| 14.2 | 5/8" | 50 x 5 | 200P10 | BR2-4-142505 | HCPK4 | - | - |
| 14.2 | 5/8" | 50 x 6 | 250P10 | BR2-4-142506 | HCPK4 | - | - |
| 17.2 | 3/4" | 20 x 3 | 150P10 | BR2-4-172203 | HCPK4 | - | - |
| 17.2 | 3/4" | 25 x 3 | 150P10 | BR2-4-172253 | HCPK4 | - | - |
| 17.2 | 3/4" | 25 x 4 | 200P10 | BR2-4-172254 | HCPK4 | - | - |
| 17.2 | 3/4" | 25 x 6 | 200P10 | BR2-4-172256 | HCPK4 | - | - |
| 17.2 | 3/4" | 30 x 2 | 150P10 | BR2-4-172302 | HCPK4 | - | - |
| 17.2 | 3/4" | 30 x 3 | 150P10 | BR2-4-172303 | HCPK4 | - | - |
| 17.2 | 3/4" | 30 x 4 | 250P10 | BR2-4-172304 | HCPK4 | - | - |
| 17.2 | 3/4" | 30 x 5 | 200P10 | BR2-4-172305 | HCPK4 | - | - |
| 17.2 | 3/4" | 31 x 3 | 200P10 | BR2-4-172313 | HCPK4 | - | - |
| 17.2 | 3/4" | 31 x 6 | 250P10 | BR2-4-172316 | HCPK4 | - | - |
| 17.2 | 3/4" | 38 x 3 | 200P10 | BR2-4-172383 | HCPK4 | - | - |
| 17.2 | 3/4" | 38 x 5 | 200P10 | BR2-4-172385 | HCPK4 | - | - |
| 17.2 | 3/4" | 38 x 6 | 250P10 | BR2-4-172386 | HCPK4 | - | - |
| 17.2 | 3/4" | 40 x 3 | 200P10 | BR2-4-172403 | HCPK4 | - | - |
| 17.2 | 3/4" | 40 x 4 | 200P10 | BR2-4-172404 | HCPK4 | - | - |
| 17.2 | 3/4" | 40 x 5 | 200P10 | BR2-4-172405 | HCPK4 | - | - |
| 17.2 | 3/4" | 40 x 6 | 250P10 | BR2-4-172406 | HCPK4 | - | - |
| 17.2 | 3/4" | 50 x 3 | 2 x 150P10 | BR2-5-172503 | HCPK5 | - | - |
| 17.2 | 3/4" | 50 x 4 | 2 x 150P10 | BR2-5-172504 | HCPK5 | - | - |
| 17.2 | 3/4" | 50 x 5 | 2 x 150P10 | BR2-5-172505 | HCPK5 | - | - |
| 17.2 | 3/4" | 50 x 6 | 2 x 150P10 | BR2-5-172506 | HCPK5 | - | - |

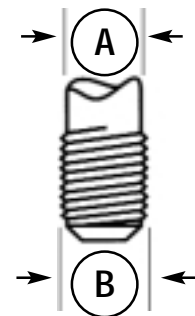
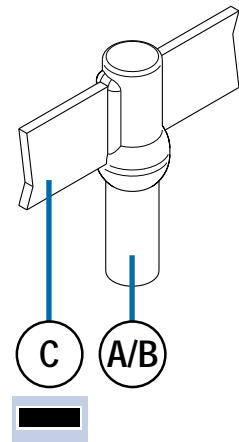

Suitable for connections to copperbond rods - for connections to solid copper and stainless steel rods please contact our sales office.

Threaded portion of copperbond rods must be removed prior to welding.